

Rev No.	Description	Date	Name
A	First light	09/07/08	A.Vismara

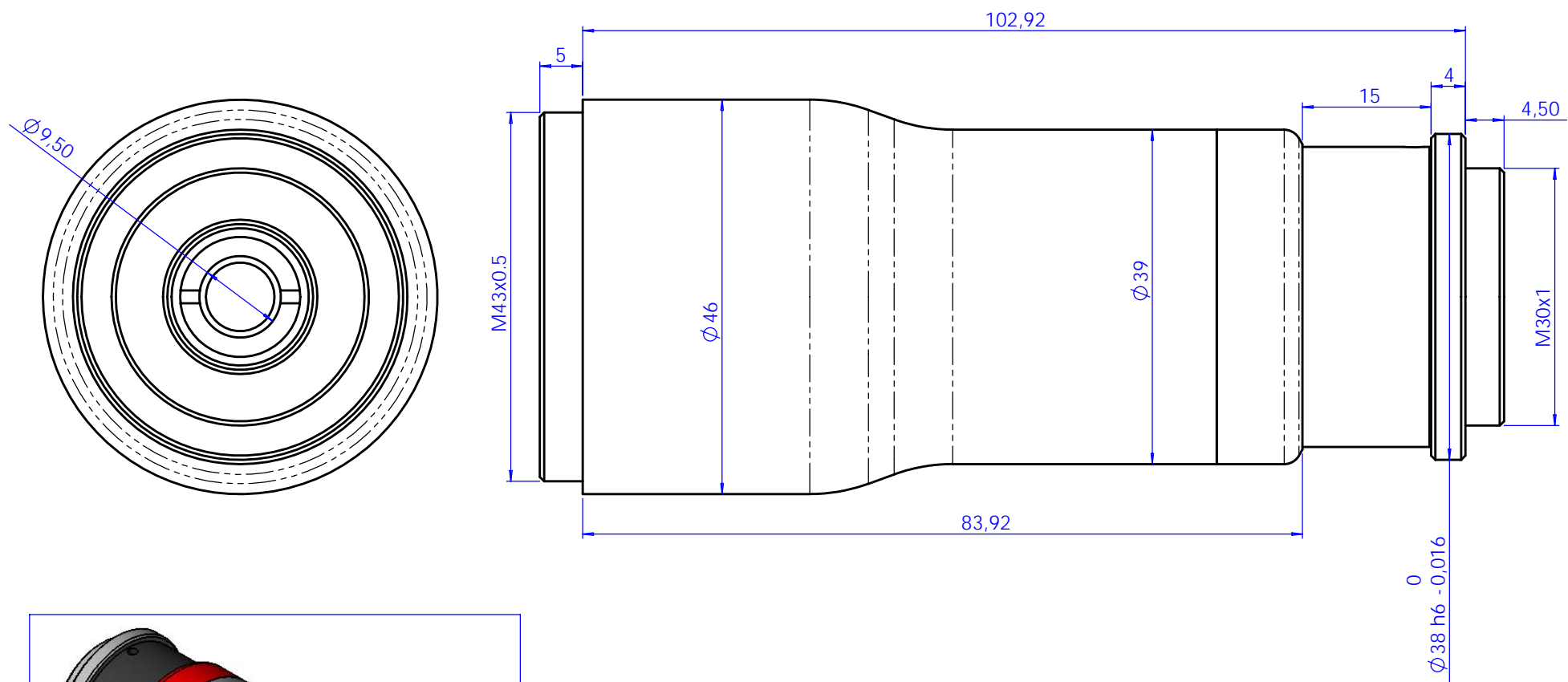

Material	N.A.		Mass	303.2 g	Scale	2:1	
Surface treatment	N.A.		Project-Prod.Item/Instrument Beam Expander				
Geometrical tolerance (ISO 2768-2)		Class	K	Undimensioned bevels	1x45°	Description LAYOUT OF BEAM EXPANDER 8X, 1064 nm	
Linear tolerance (ISO 2768-2)		Class	m	Undimensioned radii	R 0.5		
0.5	>3-	>6-	>30-	>120	>400-	>1000	>2000
+3	6	30	120	+400	+1000	+2000	+4000
±0.1	±0.1	±0.2	±0.3	±0.5	±0.8	±1.2	±2
Material		Date		Name		Drawing No.	Sheet
		Designed		A.Vismara		DD00008-A	1/1
		Draw		A.Vismara			
		Checked		C. Sedazzari			
OMI - OPTOMECHANICAL INDUSTRIES S.r.l. - 46100 Mantova (MN) Italy - via Cremona 29/2 - Tel. +39 0376 263525 - e-mail: info@optomechanicalindustries.com							